

NOTES:

1. Material : Stainless Steel
2. Finish : Glod Irridite
3. Ends : Closed and Ground
4. Total Coils : 8.000
5. Sugg. Max. Deflection : 0.190 (in)
6. Sugg. Max. Load : 2.300 (lbs)
7. All Drawing Dimensions are in Inches [mm]

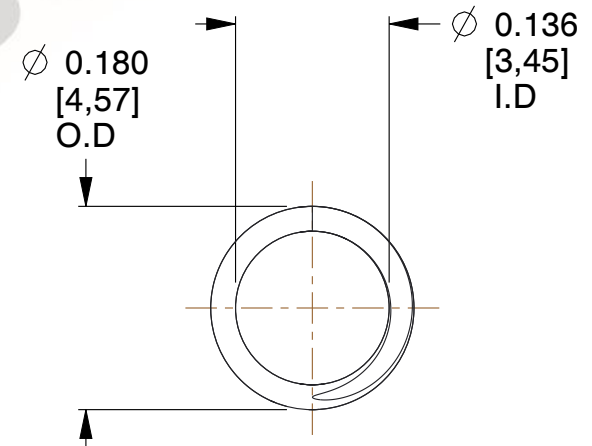

\varnothing 0.022
 [0,56]
 WIRE DIA

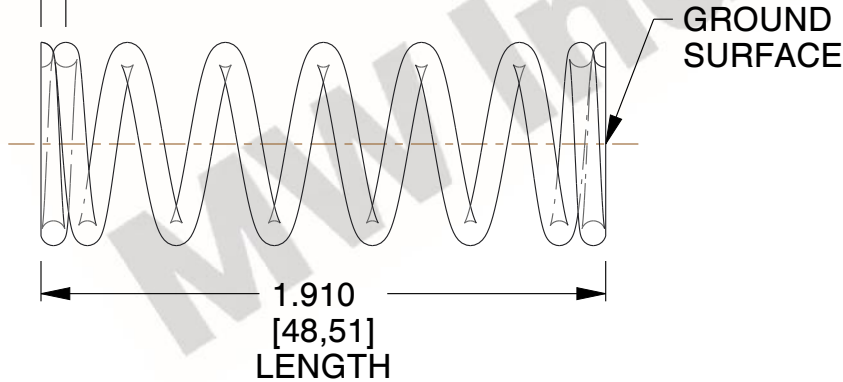

COMPONENT		SPRINGS	
70347S COMPRESSION SPRINGS		UNIT	INCH [mm]
		SHEET	1 of 1