

NOTES:

1. Material : Stainless Steel
2. Finish : Glod Irridite
3. Ends : Closed
4. Total Coils : 10.500
5. Sugg. Max. Deflection : 0.570 (in)
6. Sugg. Max. Load : 3.100 (lbs)
7. All Drawing Dimensions are in Inches [mm]

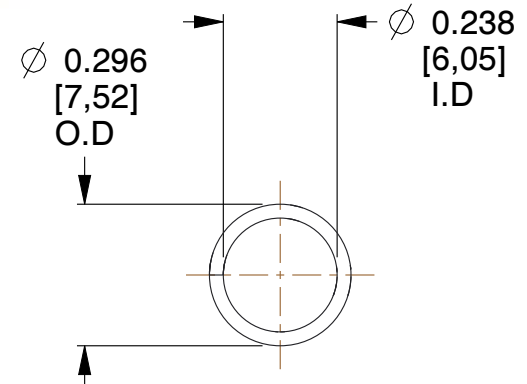
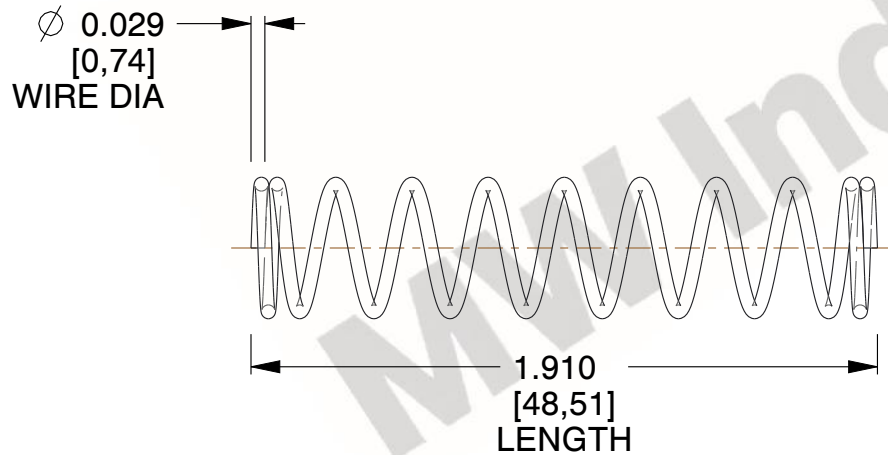

COMPONENT		SPRINGS	
S-3076 COMPRESSION SPRINGS		UNIT	INCH [mm]
		SHEET	1 of 1