

NOTES:

1. Material : Stainless Steel
2. Finish : Glod Irridite
3. Ends : Closed and Ground
4. Total Coils : 3.000
5. Sugg. Max. Deflection : 0.570 (in)
6. Sugg. Max. Load : 0.170 (lbs)
7. All Drawing Dimensions are in Inches [mm]

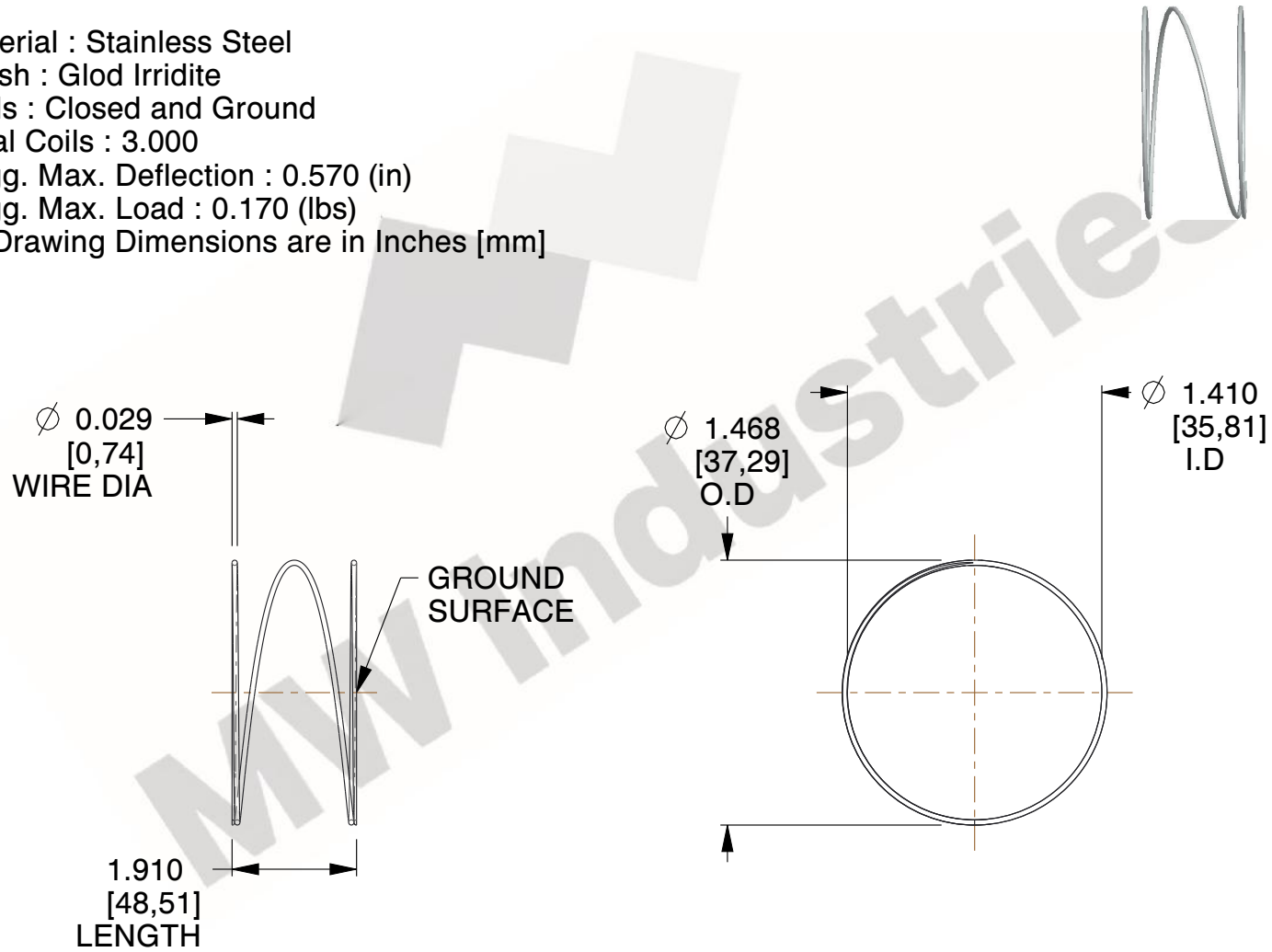

COMPONENT		SPRINGS	
S-3052		UNIT	
		INCH [mm]	
		SHEET	
COMPRESSION SPRINGS		1 of 1	