

**NOTES:**

1. Material : Music Wire
2. Finish : Glod Irridite
3. Ends : Closed and Ground
4. Total Coils : 29.600
5. Sugg. Max. Deflection : 1.100 (in)
6. Sugg. Max. Load : 18.000 (lbs)
7. All Drawing Dimensions are in Inches [mm]

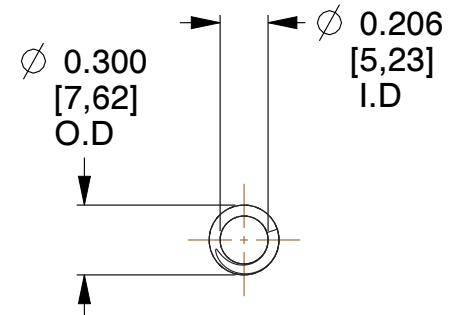

$\varnothing$  0.047  
 [1,19]  
 WIRE DIA

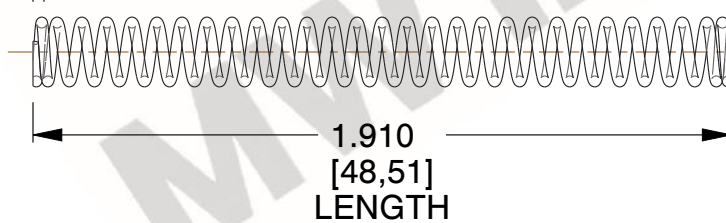

COMPONENT		SPRINGS	
<b>70983</b>  COMPRESSION SPRINGS		UNIT	INCH [mm]
		SHEET	1 of 1