

NOTES:

1. Material : Spring Steel
2. Finish : Zinc - Z
3. Ends : Closed and Ground
4. Total Coils : 10.000
5. Sugg. Max. Deflection : 3.700 (in)
6. Sugg. Max. Load : 2.700 (lbs)
7. All Drawing Dimensions are in Inches [mm]

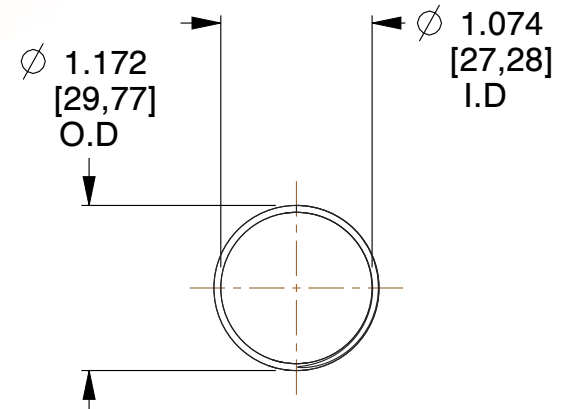
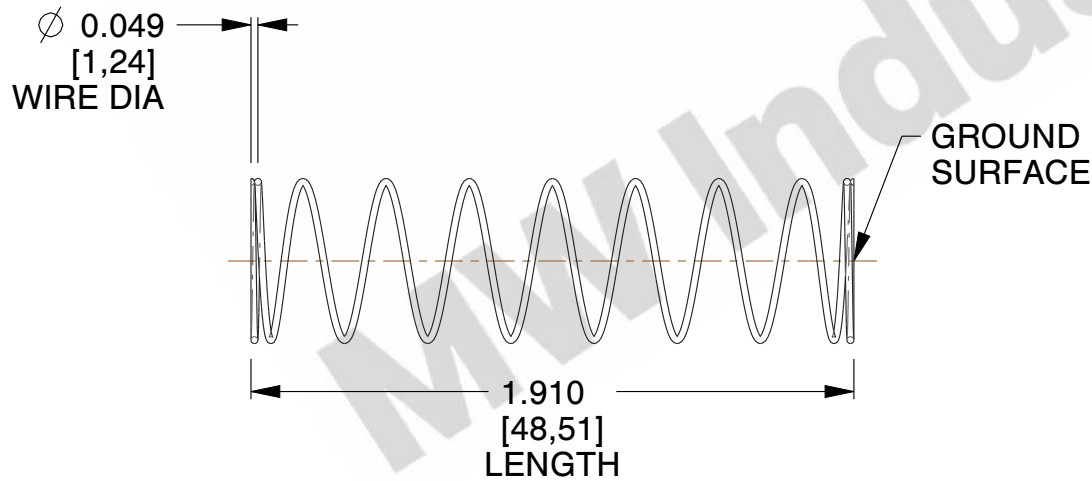
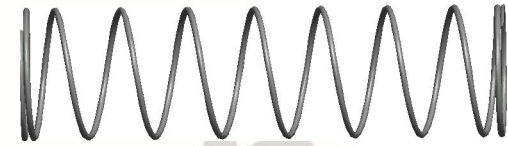

COMPONENT		SPRINGS	
3670 COMPRESSION SPRINGS		UNIT	INCH [mm]
		SHEET	1 of 1