

NOTES:

1. Material : Spring Steel
2. Finish : Glod Irridite
3. Ends : Closed and Ground
4. Total Coils : 5.500
5. Sugg. Max. Deflection : 0.130 (in)
6. Sugg. Max. Load : 22.000 (lbs)
7. All Drawing Dimensions are in Inches [mm]

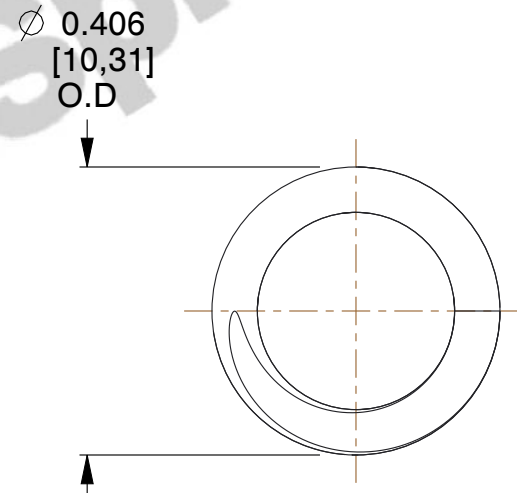
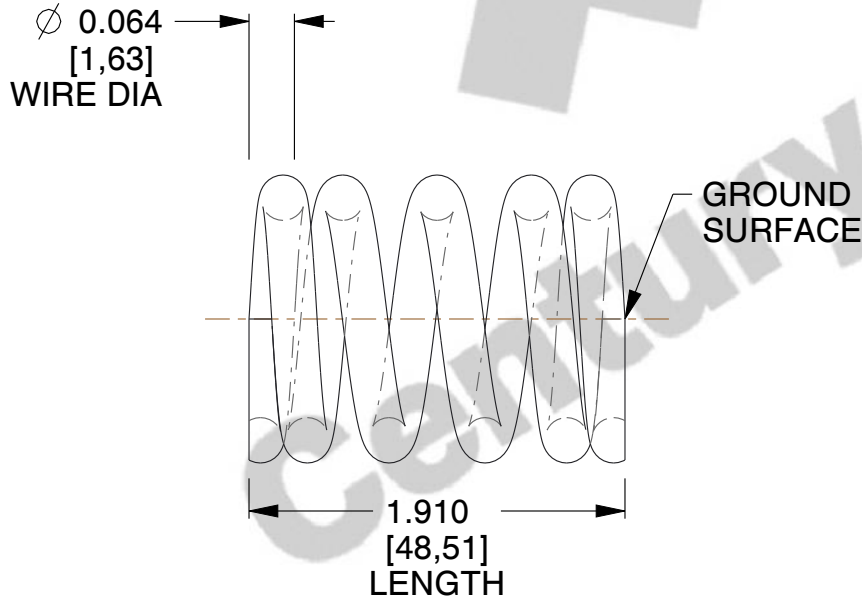
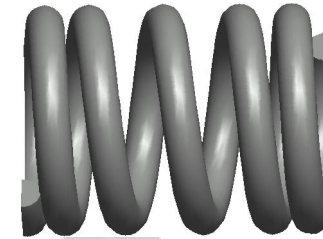

COMPONENT		SPRINGS	
10843 COMPRESSION SPRINGS		UNIT	INCH [mm]
		SHEET	1 of 1