

NOTES:

1. Material : Stainless Steel
2. Finish : Glod Irridite
3. Ends : Closed and Ground
4. Total Coils : 12.000
5. Sugg. Max. Deflection : 0.530 (in)
6. Sugg. Max. Load : 10.000 (lbs)
7. All Drawing Dimensions are in Inches [mm]

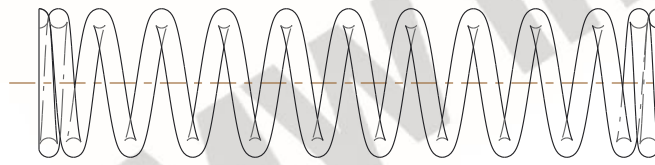

\varnothing 0.047
 [1,19]
 WIRE DIA



GROUND SURFACE

1.910
 [48,51]
 LENGTH

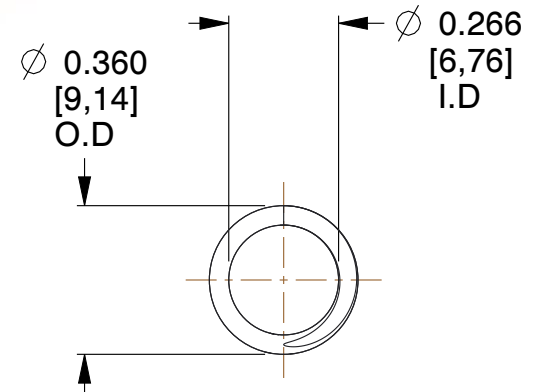

\varnothing 0.360
 [9,14]
 O.D

\varnothing 0.266
 [6,76]
 I.D

COMPONENT		SPRINGS	
71187S COMPRESSION SPRINGS		UNIT	INCH [mm]
		SHEET	1 of 1