

**NOTES:**

1. Material : Music Wire
2. Finish : Zinc - Z
3. Sugg. Max. Deflection : 500.000 Deg
4. Sugg. Max. Torque : 0.074 (in-lbs)
5. Total Coils : 8.375
6. Sugg. Mandrel Diameter : 0.170 (in)
7. All Drawing Dimensions are in Inches [mm]

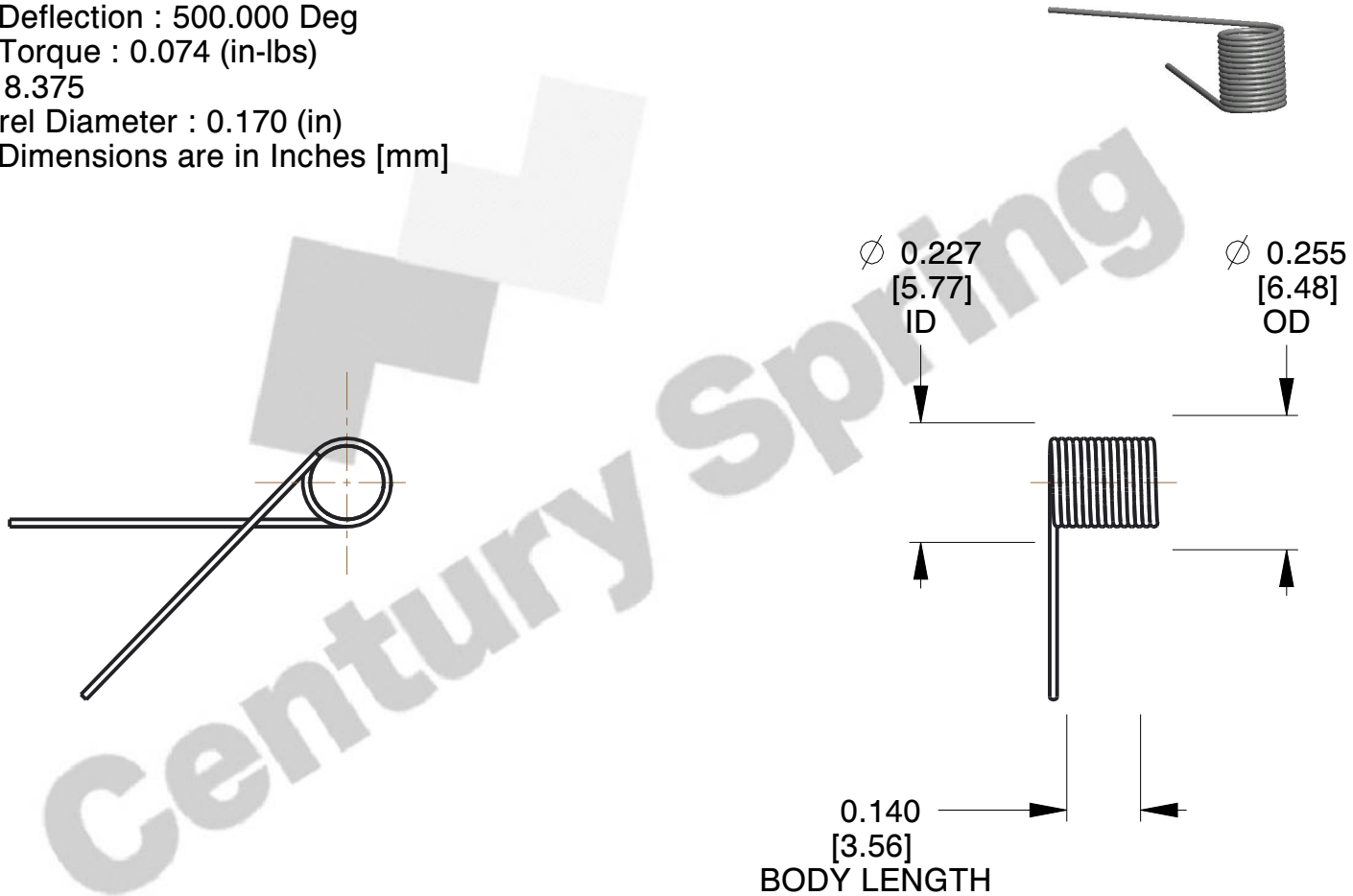

COMPONENT		TORSION SPRINGS	
<b>TO-1113</b>		UNIT	
		INCH [mm]	
		SHEET	
TORSION SPRINGS		1 of 1	