

NOTES:

1. Material : Stainless Steel
2. Finish : Zinc - Z
3. Sugg. Max. Deflection : 151.000 Deg
4. Sugg. Max. Torque : 3.500 (in-lbs)
5. Total Coils : 8.000
6. Sugg. Mandrel Diameter : 0.330 (in)
7. All Drawing Dimensions are in Inches [mm]

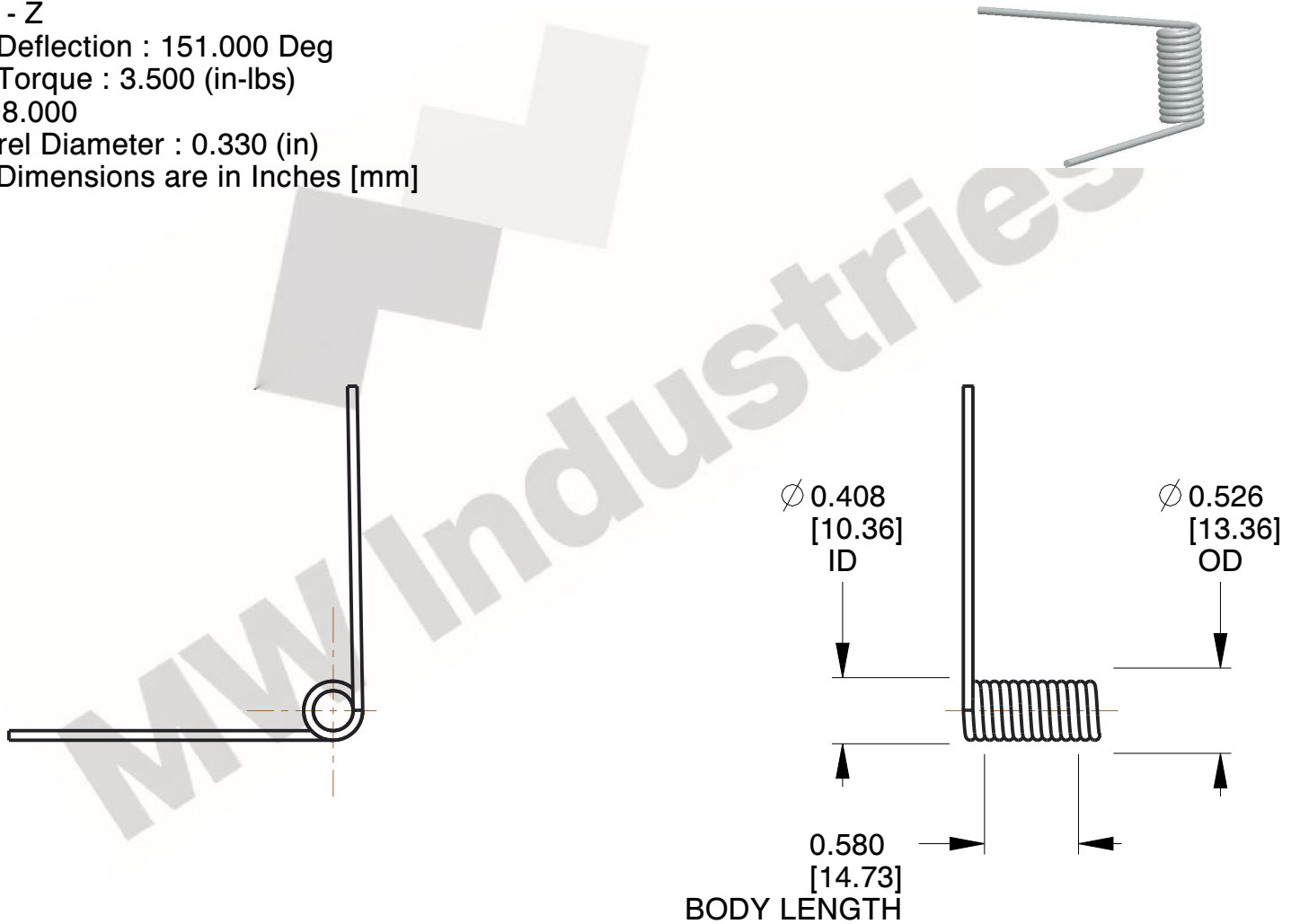

COMPONENT		TORSION SPRINGS	
TO-1091		UNIT	
		INCH [mm]	
TORSION SPRINGS		SHEET	
		1 of 1	