

NOTES:

1. Material : Stainless Steel
2. Finish : Glod Irridite
3. Ends : Closed and Ground
4. Total Coils : 12.400
5. Sugg. Max. Deflection : 0.290 (in)
6. Sugg. Max. Load : 3.000 (lbs)
7. All Drawing Dimensions are in Inches [mm]

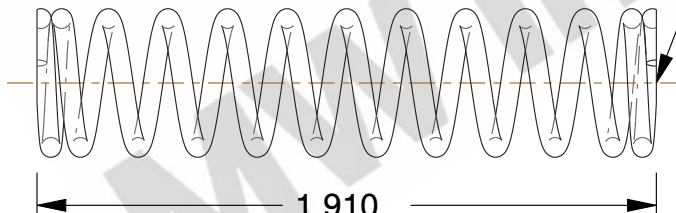

\varnothing 0.024
 [0,61]
 WIRE DIA



1.910
 [48,51]
 LENGTH

GROUND SURFACE

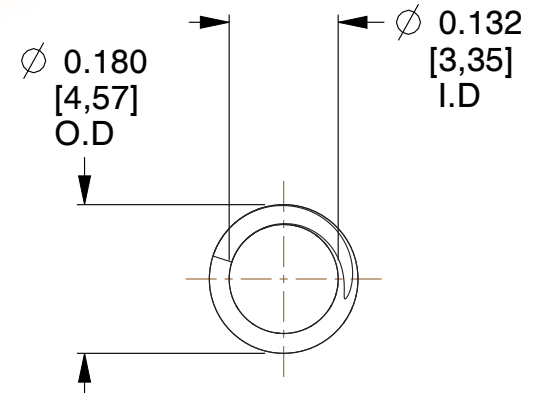

\varnothing 0.180
 [4,57]
 O.D

\varnothing 0.132
 [3,35]
 I.D

COMPONENT		SPRINGS	
70372S COMPRESSION SPRINGS		UNIT	INCH [mm]
		SHEET	1 of 1