

**NOTES:**

1. Material : Hard Drawn
2. Finish : Glod Irridite
3. Ends : Closed and Ground
4. Total Coils : 11.000
5. Sugg. Max. Deflection : 3.200 (in)
6. Sugg. Max. Load : 9.700 (lbs)
7. All Drawing Dimensions are in Inches [mm]

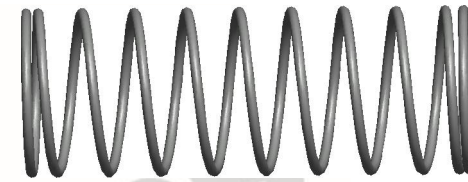

$\varnothing$  0.091  
 [2,31]  
 WIRE DIA

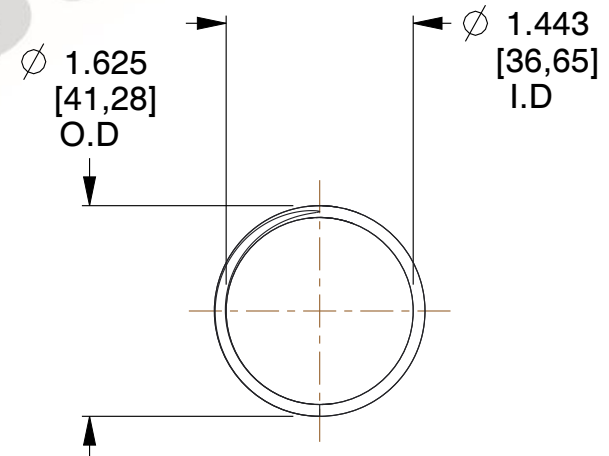
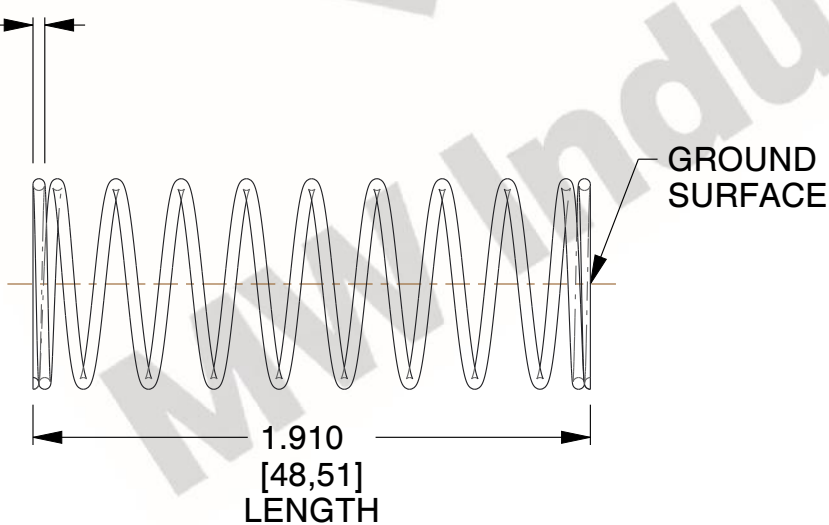

COMPONENT		SPRINGS	
<b>12725</b>  COMPRESSION SPRINGS		UNIT	INCH [mm]
		SHEET	1 of 1